



slide bases



slide bases



components



EN1728

slide bases showing



tools



certification / mod. SL40



L'ideale fondamento per ogni vostro progetto.

L'assortimento di basi **AlbaComponents** offre un **grande numero di soluzioni** in grado di rispondere alle più varie esigenze in termini di design, e di garantire i più elevati standard qualitativi.

The ideal foundation for all your projects.

The AlbaComponents range of bases offers a large selection of solutions capable of meeting the most varied needs in terms of design, and ensuring you the highest quality standards.

slide bases

components

main component sizes

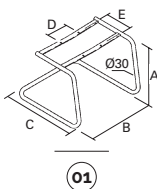

01 sl43-base a slitta in tubo ø30 tappi esclusi
sl43-slide frame pipe ø30 without caps

code	finishing	q.kit	q.pack	a	b	c	d	e	kg.x1	vol.x1
110503-003	● nero/black	x1	64	400	530	530	155	200	4,70	mc. 0.0313
110504-001	● grigio/grey	x1	64	400	530	530	155	200	4,70	mc. 0.0313
110510-020	● cromato/chrome	x1	64	400	530	530	155	200	4,70	mc. 0.0313

02 confezione tappi copritesta ø30 nero + pinze a due pioli p2p
black round cover head caps ø30 + two pins pliers in black polythene package

code	finishing	q.kit	q.pack
137003-077	● nero/black	tc30 (x2) - p2p (x6)	tc30 (130 pcs) - p2p (390 pcs)

main component sizes

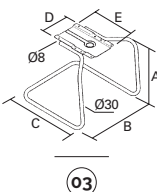

03 sl40-base a slitta in tubo ø25 tappi esclusi
sl40-slide frame pipe ø25 without caps

code	finishing	q.kit	q.pack	a	b	c	d	e	kg.x1	vol.x1
110503-021	● nero/black	x1	96	430	480	520	170	200	4,10	mc. 0.0313
110504-010	● grigio/grey	x1	96	430	480	520	170	200	4,10	mc. 0.0313
110510-002	● cromato/chrome	x1	96	430	480	520	170	200	4,10	mc. 0.0313

04 confezione tappi copritesta alettati ø25 neri + pinze a due pioli p2p
black round cover head caps d25 + two pins pliers in black polythene package

code	finishing	q.kit	q.pack
137003-076	● nero/black	tc25 (x2) - p2p (x6)	tc25 (195 pcs) - p2p (580 pcs)

05 piedino antiribaltamento in plastica nero + 2 viti
plastic black feet anti-upsetting + 2 screws

code	finishing	q.kit
134303-006	● nero/black	x2

main component sizes

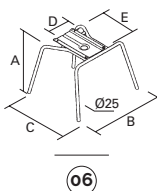

06 rg31-telaio fisso in tubo ø25 tappi esclusi
rg31-fixed frame pipe ø25 without caps

code	finishing	q.kit	q.pack	a	b	c	d	e	kg.x1	vol.x1
110603-012	● nero/black	x1	150	430	470	550	170	200	3,70	mc. 0.028
110604-041	● grigio/grey	x1	150	430	470	550	170	200	3,70	mc. 0.028
110610-017	● cromato/chrome	x1	150	430	470	550	170	200	3,70	mc. 0.028

07 puntale alettato tondo ø25 nero
ribbed round insert cap ø25 black

code	finishing	q.kit
134203-253	● nero/black	x4

slide bases

components

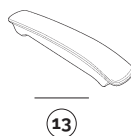
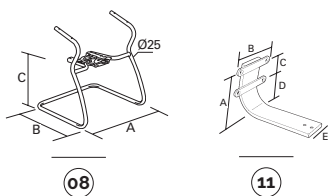
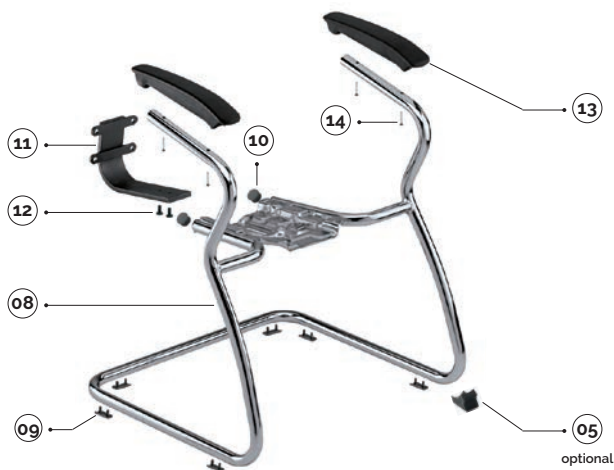

main component sizes

for the component below, see page 226

08 sl45-base a slitta in tubo ø25 con braccioli, tappi esclusi
sl45-slide frame pipe ø25 with arms without caps

code	finishing	q.kit	q.pack	a	b	c	kg.x1	vol.x1
110503-005	● nero/black	x1	50	590	560	400	5,50	mc. 0.055
110504-015	● grigio/grey	x1	50	590	560	400	5,50	mc. 0.055
110510-045	● cromato/chrome	x1	50	590	560	400	5,50	mc. 0.055

09 pinza due pioli in polietilene nera
two pins pliers in black polythene

code	finishing	q.kit
134003-003	● nero/black	x6

10 tappo copritesta alettato ø25 nero
ribbed insert ø25 black

code	finishing	q.kit
134103-250	● nero/black	x2

11 schienale fisso per base sl45/sl46
fixed back for base sl45 / sl46

code	finishing	q.kit	q.pack	a	b	c	d	e	kg.x1	vol.x1
112103-220	● nero/black	x1	10	130	100	60	70	60	1,70	mc. 0.0015

12 vite m8x25 testa cilindrica esagono incassato brunita (per fissaggio lama/piastra)
screw m8x25 cylindrical head exagon heat burnishing (for blade/plate)

code	finishing	q.kit
117703-240	● nero/black	x2

13 copribracciolo in poliuretano per base sl45 tubo ø25
cover arm in polyurethane for base sl45 tube ø25

code	finishing	q.kit	q.pack	kg.x1	vol.x1
131703-045	● nero/black	x2	25	0,24	mc. 0.001

14 vite autoflettante 5,5x38 testa svasata a croce zincata (per fissaggio copribracciolo)
screw auto-thread 5,5x38 flared cross head zinc (for fix cover arm)

code	finishing	q.kit
117811-165	● zincata/zinc	x4

slide bases

components



15 sl46-base a slitta in tubo 25 tappi esclusi
sl46-slide frame pipe ø25 without caps

code	finishing	q.kit	q.pack	a	b	c	kg.x1	vol.x1
110503-007	● nero/black	x1	64	590	560	400	4,50	mc. 0.032
110504-020	● grigio/grey	x1	64	590	560	400	4,50	mc. 0.032
110510-047	● cromato/chrome	x1	64	590	560	400	4,50	mc. 0.032

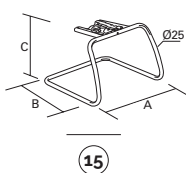

main component sizes



16 piastra adattatore per lama schienale
adapter plate for blade back

code	finishing	q.kit	q.pack	kg.x1	vol.x1
113003-150	● nero/black	x1	30	0,45	mc. 0.001

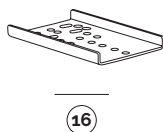

main component sizes

slide bases

components



main component sizes

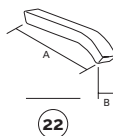
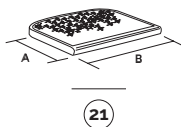
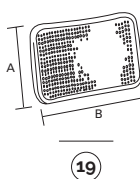
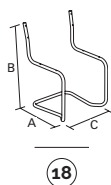
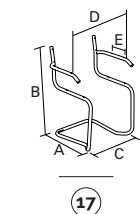

- 17** sl54-base a slitta in tubo $\varnothing 25 \times 2$ con braccioli + tappi assemblati
sl54-slide frame pipe $\varnothing 25 \times 2$ with arms + caps assembled

code	finishing	q.kit	q.pack	a	b	c	d	e	kg.x1	vol.x1
110503-037	● nero/black	x1	80	450	770	450	500	140	4,90	mc. 0,04
110504-027	● grigio/grey	x1	80	450	770	450	500	140	4,90	mc. 0,04
110510-082	● cromato/chrome	x1	80	450	770	450	500	140	4,90	mc. 0,04

- 18** sl53-base a slitta in tubo $\varnothing 25 \times 2$ con tappi assemblati
sl53-slide frame pipe $\varnothing 25 \times 2$ caps assembled

code	finishing	q.kit	q.pack	a	b	c	kg.x1	vol.x1
110503-035	● nero/black	x1	120	450	770	450	4,10	mc. 0,04
110504-025	● grigio/grey	x1	120	450	770	450	4,10	mc. 0,04
110510-080	● cromato/chrome	x1	120	450	770	450	4,10	mc. 0,04

- 19** 53sh-schienale in faggio verniciato in canna
53sh-beech back cane painted

code	finishing	q.kit	q.pack	a	b	kg.x1	vol.x1
122103-005	● nero/black	x1	10	270	460	0,73	mc. 0,005
122107-005	● naturale/natural	x1	10	270	460	0,73	mc. 0,005

- 20** vite truciolare testa svasata bombata a croce $\varnothing 4,2 \times 38$
shaving screw flared rounded cross $\varnothing 4,2 \times 38$

code	finishing	q.kit
117803-126	● nero/black	x8
117811-127	● zincata/zinc	x8

- 21** 53sd-sedile in faggio verniciato in canna
53sd-beech seat cane painted

code	finishing	q.kit	q.pack	a	b	kg.x1	vol.x1
122203-010	● nero/black	x1	10	415	465	1,37	mc. 0,008
122207-010	● naturale/natural	x1	10	415	465	1,37	mc. 0,008

- 22** 53b-coppia braccioli in faggio verniciato
53b-pair of beech arms painted

code	finishing	q.kit	q.pack	a	b	kg.x1	vol.x1
121703-005	● nero/black	x1	35	310	40	0,42	mc. 0,002
121707-005	● naturale/natural	x1	35	310	40	0,42	mc. 0,002

- 14** vite autofilettante $5,5 \times 38$ testa svasata a croce zincata (per fissaggio bracciolo)
screw auto-thread $5,5 \times 38$ flared cross head zinc (for fix arm)

code	finishing	q.kit
117811-165	● zincata/zinc	x4